**User's
Manual**

**Model UP150
Program
Temperature Controller**



IM 05C01F12-41E

Note: This user's manual (IM 05C01F12-41E) is a re-edited, A4-size version of the IM 05C01F12-01E user's manual that is supplied along with the product shipped. Therefore, both manuals have the same contents, except for some minor differences in the cross-referenced page numbers.

Revision Record

- Manual No. : IM 05C01F12-41E(3rd Edition)
- Title : Model UP150 Program Temperature Controller

Edition	Date	Revised Item
First	Feb.,2001	Newly published
Second	Sep.,2003	Correct
Third	Jun.,2004	Change of the company name.

Please read through this user’s manual to ensure correct usage of the controller and keep it handy for quick reference.

CONTENTS

1.	Notice	2
2.	What is on the Front Panel?	3
3.	Installing the Controller	4
4.	Panel Cutout Dimensions and External Dimensions	5
5.	Wiring	6
6.	Hardware Specifications	9
7.	Key Operations	10
8.	Programming	18
9.	Troubleshooting	34

■ Checking Package Contents

Before using the product, check that its model & suffix codes are as you ordered.

Model and Suffix Codes

Model	Suffix code	Description
UP150		Program Temperature Controller
Control output for standard type	-R -V -A	Relay output (time-proportional PID or on/off control) Voltage pulse output (time-proportional PID) 4 to 20mA output (continuous PID)
Fixed code	N	Always N
Option	/EX /RET /RS /V24	RUN/RESET switching, and HOLD program/cancel HOLD program switching by external contacts (Note1) PV retransmission output in 4 to 20mA Communication function (MODBUS, PC-Link, Ladder) (Note1) (Note2) Power Supply 24V DC / 24V AC

Note1: /RS option and /EX option cannot be specified at the same time.

Note2: When specifying the /RS option, be sure to order the required number of copies of Communication Functions User's Manual separately.

Check the package contents against the list below.

- Program temperature controller 1
- Mounting bracket 1
- User's manual 1

1. NOTICE

The following safety symbol is used both on the product and in this user's manual.



This symbol stands for “Handle with Care.” When displayed on the product, the operator should refer to the corresponding explanation given in the user's manual in order to avoid injury or death of personnel and/or damage to the product. In the manual the symbol is accompanied by an explanation of the special care that is required to avoid shock or other dangers that may result in injury or loss of life.

The following symbols are used in this manual only.



Indicates that operating the hardware or software in a particular manner may lead to damage or result in system failure.



Draws attention to information that is essential for understanding the operation and/or features of the product.

■ Exemption from Responsibility

Make sure that all of the precautions are strictly adhered to. Yokogawa Electric Corporation assumes no liability for any damage resulting from use of the instrument in contradiction to the precautions. Also, Yokogawa Electric Corporation assumes no liability to any party for any loss or damage, direct or indirect, caused by the use or any unpredictable defect of the instrument.

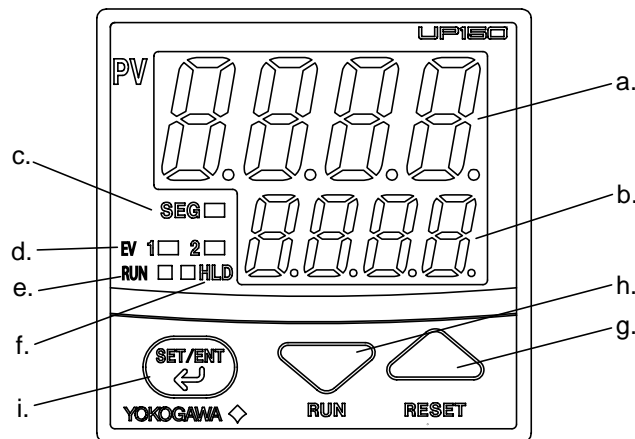

2. WHAT IS ON THE FRONT PANEL?



■ Monitoring Parts

	Name	Function
a.	PV display (red)	Indicates PV (measured value) and character information such as parameter codes and error codes. Indicates PV and "AT" alternately during Auto-tuning.
b.	SP display (green)	Indicates SP (target setpoint), segment no., remaining segment time and parameter setpoints on SP display.
c.	SEG lamp (green)	Lit when the value of segment no. or remaining segment time is displayed.
d.	EV1, EV2 lamps (red)	EV1 : Lit when event 1 (PV event 1 or Time event 1) is activated. EV2 : Lit when event 2 (PV event 2 or Time event 2) is activated.
e.	RUN lamp (orange)	Lit while the operation mode is "RUN". Flashing while the operation mode is "WAIT".
f.	HLD (hold) lamp (green)	Lit while the operation mode is "HOLD".

■ Operating Parts (See 7. Key operations)

	Name	Function
g.	Data change key (or Reset key) 	<ul style="list-style-type: none"> Pressing this key for more than 1 second (in operating display) stops (resets) the program operation. Changes the program setpoints(SP) and the parameter setpoints. Pressing this key increases the parameter setpoint. Holding down the key will gradually increase the speed of changes.
h.	Data change key (or Run key) 	<ul style="list-style-type: none"> Pressing this key for more than 1 second (in operating display) starts (runs) the program operation. Changes the program setpoints(SP) and the parameter setpoints. Pressing this key decreases the parameter setpoint. Holding down the key will gradually decrease the speed of changes.
i.	SET/ENT key (data registering key) 	<ul style="list-style-type: none"> Switches the operating displays ①, ② and ③. Registers the data value changed using the data change keys. Switches between parameter setting displays sequentially. Pressing the key for 3 seconds or longer in the operating display retrieves the operating parameter setting display. Pressing the key for 3 seconds or longer in operating, setup or program parameter setting display transfers back to operating display ①.

3. INSTALLING THE CONTROLLER



To prevent electric shock, the source of power to the controller must be turned off when mounting the controller on to a panel.



To install the controller, select a location where:

1. No-one may accidentally touch the terminals;
2. Mechanical vibrations are minimal;
3. Corrosive gas is minimal;
4. The temperature can be maintained at about 23°C with minimal fluctuation;
5. There is no direct heat radiation;
6. There are no resulting magnetic disturbances;
7. The terminal board (reference junction compensation element, etc.) is protected from wind;
8. There is no splashing of water; and
9. There are no flammable materials.

Never place the controller directly on flammable items.

If the controller has to be installed close to flammable items or equipment, be sure to enclose the controller in shielding panels positioned at least 150mm away from each side. These panels should be made of either 1.43mm thick metal-plated steel plates or 1.6mm thick uncoated steel plates.

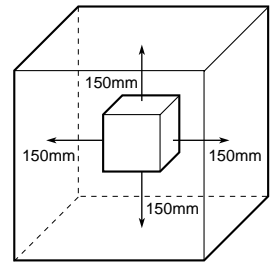

- Mount the controller at an angle within 30° from horizontal with the screen facing upward. Do not mount it facing downward.

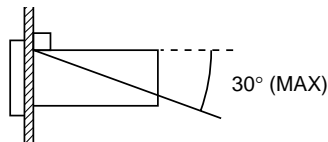

■ Mounting the Controller

1. Affix the bracket over the back end of the controller.

2. Push the bracket to the panel, and then secure the bracket into position.

[How to remove the bracket]
To remove the bracket, push down the center of the upper and lower parts of the controller softly. The bracket is released from the latch.

4. PANEL CUTOUT DIMENSIONS AND EXTERNAL DIMENSIONS



Splash-proof construction is not available when the side-by-side close mounting method shown in the following figures, is chosen for any of the controller.

1. General Mounting

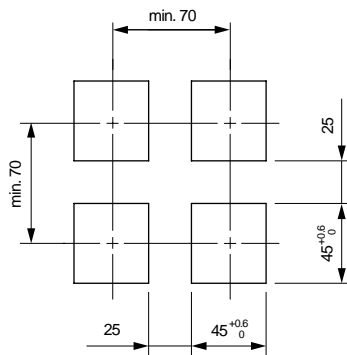

2. Side-by-side Close Mounting

(Splash-proof construction is unavailable)

Unit: mm

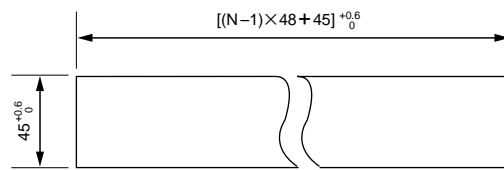

N is the number of controllers.
If $N \geq 5$, then measure the actual length.

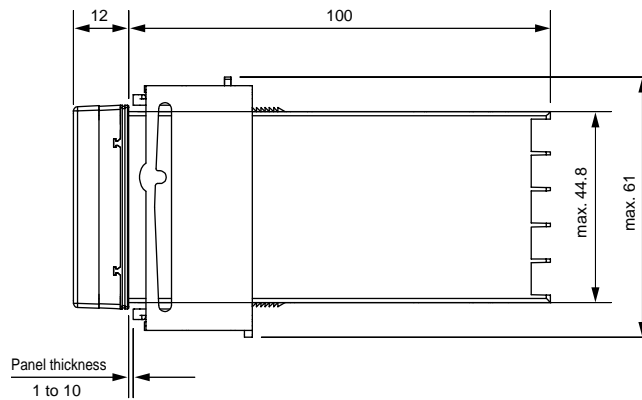
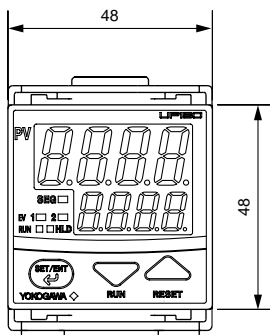
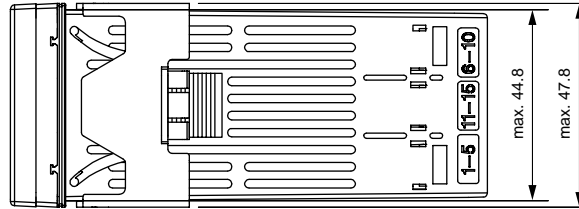

5. WIRING



- 1) Before you start wiring, turn off the power source and use a tester to check that the controller and cables are not receiving any power in order to prevent electric shock.
 - 2) For safety, be sure to install a circuit breaker switch (of 5A and 100V AC or 220V AC, and that conforms to IEC60947) near the instrument so as to be operated easily, and clearly indicate that the device is used to de-energize the instrument.
 - 3) Wiring should be carried out by personnel with appropriate electrical knowledge and experience.
-



- 1) Use a single-phase power source. If the source has a lot of noise, use an isolation transformer for the primary side and a line filter (we recommend TDK's ZAC2205-00U product) for the secondary side. When this noise-prevention measure is taken, keep the primary and secondary power cables well apart. Since the controller has no fuse, be sure to install a circuit breaker switch (of 5A and 100V AC or 220V AC, and that conforms to IEC standards) and clearly indicate that the device is used to de-energize the controller.
 - 2) For thermocouple input, use shielded compensating lead wires. For RTD input, use shielded wires which have low resistance and no resistance difference between the 3 wires. See the table given later for the specifications of the cables and terminals and the recommended products.
 - 3) The control output relay cannot be replaced even though it has a limited service life (100,000 relay contacts for the resistance load). Thus, an auxiliary relay should be used so that the load can be turned on and off.
 - 4) When using an inductive load (L) such as an auxiliary relay and solenoid valve, be sure to insert a CR filter (for AC) or diode (for DC) in parallel as a spark-rejecting surge suppressor to prevent malfunctions or damage to the relay.
 - 5) When there is the possibility of being struck by external lightning surge, use the arrester to protect the instrument.
-



Always fix a terminal cover bracket to the UP150 program temperature controller before wiring if an optional anti-electric-shock terminal cover (part number: L4000FB) is used.

● Cable Specifications and Recommended Products

Power supply and relay contact output	600V vinyl insulated wire/cable, JIS C3307, 0.9 to 2.0mm ²
Thermocouple input	Shielded compensating lead wire, JIS C1610
RTD input	Shielded wire (3-wire), UL2482 (Hitachi cable)
Other signals	Shielded wire

● Recommended Terminals

Use M3.5 screw-compatible crimp-on terminals with an insulating sleeve, as shown below.

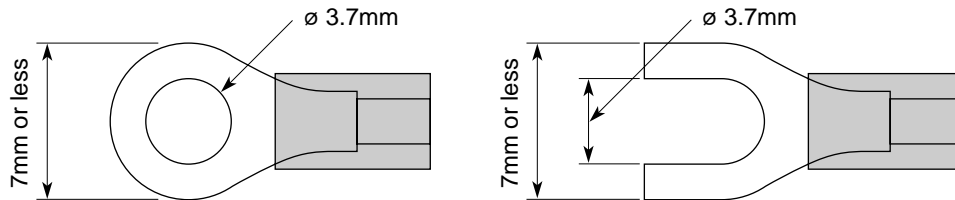

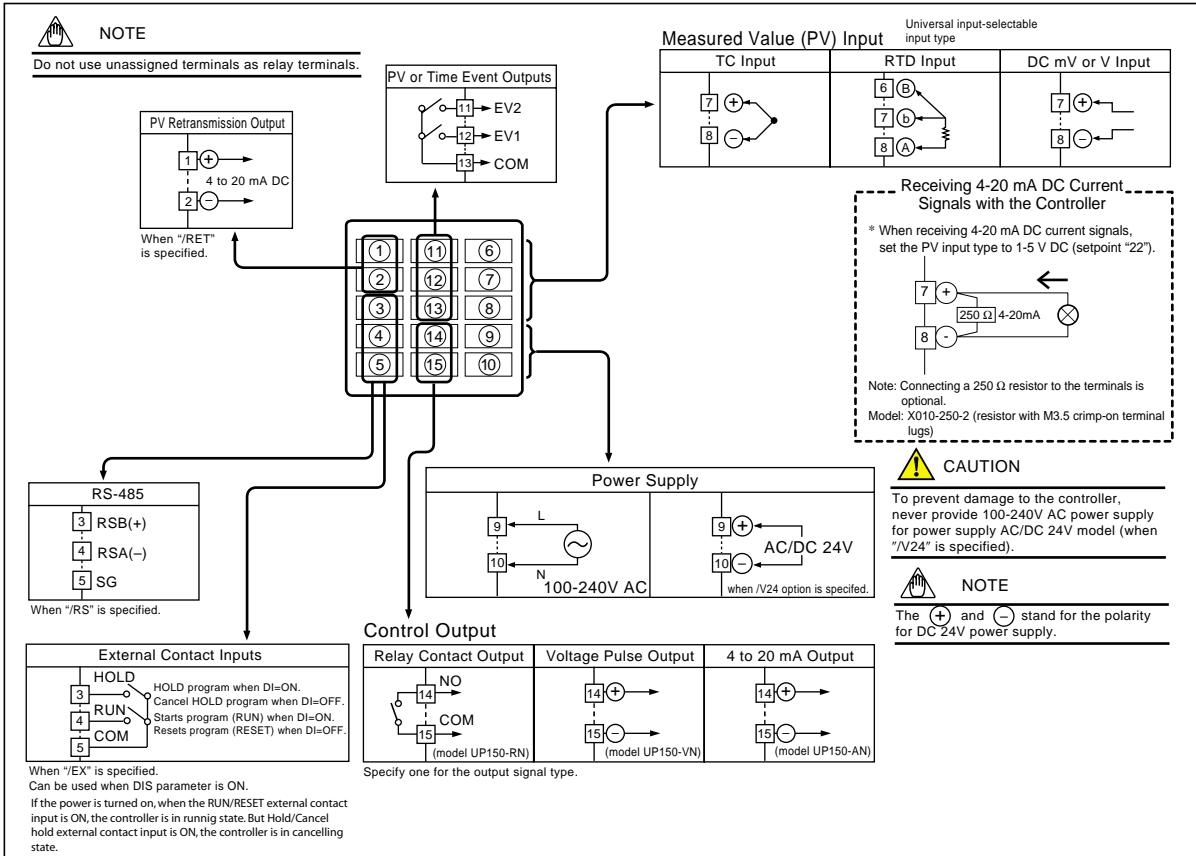

6. HARDWARE SPECIFICATIONS

Measured Value (PV) Input

- Input: 1 point
 - Input type: Universal; can be selected by software
 - Input accuracy (at 23 ±2°C ambient temperature)
 - Thermocouple: ±2°C ±1digit
 - However,
 - ±4°C for thermocouple input -200 to -100°C
 - ±3°C for thermocouple input -100 to 0°C
 - ±5°C for types R and S (±9°C for 0 to 500°C)
 - ±9°C for type B (accuracy is not guaranteed for 0 to 400°C)
 - RTD: ±1°C ±1digit
 - Voltage(mV, V): ±0.3% ±1digit
 - Sampling period for measured value input: 500ms
 - Burn-out detection: Functions for thermocouple or RTD input (burn-out upscale only; cannot be switched off)
 - Input resistance: 1MΩ or greater for thermocouple or DC mV input. Approx. 1MΩ for DC V input
 - Maximum allowable signal source resistance : 250Ω for thermocouple or DC mV input 2kΩ for DC V input
 - Maximum allowable wiring resistance for RTD input: 10Ω/wire (The resistance values of three wires must be the same.)
 - Allowable input voltage: ±10V DC for thermocouple or DC mV input ±20V DC for DC V input
 - Noise rejection ratio: Normal mode noise: Min. 40dB (50/60Hz) Common mode noise: Min. 120dB (Min. 90dB for DC V input)
 - Error of reference junction compensation: ±1.5°C (at 15-35°C) ±2.0°C (at 0-50°C)
- The reference junction compensation cannot be switched off.
- Applicable standards: Thermocouple and resistance temperature detector(RTD) JIS/IEC/DIN (ITS90)

Manual Setting (SP) Output

- SP (target setpoint) will be output in 3 seconds after the change.
- Output: 1 point
 - Output type: Current output
 - Output signal: 4 to 20mA current output
 - Maximum load resistance: 600Ω
 - Output accuracy: ±0.3% of span (at 23±2°C ambient temperature)

Alarm Functions

- Alarm Functions
 - Alarm types: 22 types (waiting action can be set by software): PV high limit, PV low limit, Deviation high limit, Deviation low limit, De-energized on deviation high limit, De-energized on deviation low limit, Deviation high and low limits, Deviation within high and low limits, De-energized on PV high limit, De-energized on PV low limit, Fault diagnosis output, FAIL output
 - Alarm output: 2 relay contacts
 - Relay contact capacity: 1A at 240V AC or 1A at 30V DC (with resistance load) (COM terminal is common)
 - Note: The alarm output relays cannot be replaced by users

Retransmission Output

- Output signal: Measured value in 4-20mA DC, can be scaled.
- Maximum load resistance: 600Ω
- Output accuracy: ±0.3% of span (at 23±2°C ambient temperature)

Safety and EMC Standards

- Safety: Compliant with IEC/EN61010-1: 2001, approved by CSA1010, approved by UL508.
 - Installation category : CAT. II (IEC/EN61010, CSA1010) Pollution degree : 2 (IEC/EN61010, CSA1010)
 - Measurement category : I (CAT. I : IEC/EN61010)
 - Rated measurement input voltage : 10V DC max. (across terminals), 300V AC max. (across ground)
 - Rated transient overvoltage : 1500V (Note)
 - Note : It is a value on the safety standard which is assumed by IEC/EN61010-1 in measurement category I, and is not the value which guarantees an apparatus performance.
 - Caution: This equipment has Measurement category I, therefore do not use the equipment for measurements within measurement categories II, III and IV.

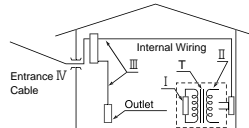

Measurement category	Description	Remarks
I CAT. I	For measurements performed on circuits not directly connected to MAINS.	
II CAT. II	For measurements performed on circuits directly connected to the low voltage installation.	Appliances, portable equipments, etc.
III CAT. III	For measurements performed in the building installation.	Distribution board, circuit breaker, etc.
IV CAT. IV	For measurements performed at the source of the low-voltage installation.	Overhead wire, cable systems, etc.

- EMC standards: Complies with EN61326. The instrument continues to operate at a measuring accuracy of within ±20% of the range during tests.

Power Supply and Isolation

Power Supply

Power supply	Voltage	Rated at 100-240VAC (±10%) AC/DC 24V, 20 to 29V of allowable range when $\sqrt{V24}$ is specified.
	Frequency	50 or 60Hz
Maximum power consumption		8VA max. (4W max.) 3W max. when $\sqrt{V24}$ is specified.
Memory		Non-volatile memory
Withstanding voltage	Between primary terminals and secondary terminals (See Notes 1 and 2.)	1500V AC for 1 minute
Insulation resistance	Between primary terminals and secondary terminals (See Notes 1 and 2.)	20MΩ or more at 500V DC

Note 1: The primary terminals are the power supply terminals and alarm output terminals.

The secondary terminals are the analog input and output terminals.

Note 2: AC/DC 24V terminals are secondary terminals.

Isolation

The bold lines below indicate reinforced isolation, and the broken line indicates functional isolation.

<ul style="list-style-type: none"> • Power supply terminals (100-240V AC) 	<ul style="list-style-type: none"> • Power supply terminals AC/DC 24V (When $\sqrt{V24}$ is specified) • Measured value input terminals • Internal circuit
<ul style="list-style-type: none"> • Alarm output terminals (2 relay contacts) 	<ul style="list-style-type: none"> • Manual setting output terminals : 4-20 mA • Retransmission output terminals : 4-20 mA

Note: The measured value input terminals is isolated from the internal circuit.

Construction, Mounting, and Wiring

- Construction: Dust-proof and drip-proof front panel conforming to IP65. For side-by-side close installation the controller loses its dust-proof and drip-proof protection.
- Casing: ABS resin and polycarbonate
- Case color: Black
- Weight: UD310 - approx. 200g
UD320 - approx. 300g
UD350 - approx. 400g
- Mounting: Flush panel mounting
- Wiring: Screw terminals

Environmental Conditions

Normal Operating Conditions

- Warm-up time: At least 30 minutes
- Ambient temperature: 0-50°C (0-40°C when mounted side-by-side)
- Rate of change of temperature: 10°C/h or less
- Ambient humidity: 20-90% RH (no condensation allowed)
- Magnetic field: 400A/m or less
- Continuous vibrations of 5 to 14Hz: Amplitude of 1.2mm or less
- Continuous vibrations of 14 to 150Hz: 4.9m/s² (0.5G) or less
- Short-period vibrations: 14.7m/s² (1.5G) for 15 seconds or less
- Shock: 98m/s² (10G) for 11 milliseconds or less
- Mounting angle: Upward incline of up to 30 degrees; downward incline is not allowed.
- Altitude: 2000m or less above sea level

Maximum Effects from Operating Conditions

- (1) Temperature effects
- Thermocouple, DC mV and DC V input: ±2μV/°C or ±0.02% of F.S./°C, whichever is larger
 - Resistance temperature detector: ±0.05°C/°C
 - Analog output: ±0.05% of F.S./°C
- (2) Effect from fluctuation of power supply voltage (within rated voltage range)
- Analog input: ±0.2μV/V or ±0.002% of F.S./V, whichever is larger
 - Analog output: ±0.05% of F.S./V









Transportation and Storage Conditions

- Temperature: -25 to 70°C
- Humidity: 5 to 95% RH (no condensation allowed)
- Shock: Package drop height 90cm (when packed in the dedicated package)

7. KEY OPERATIONS



To prevent electric shock, the controller should be mounted on the panel so as not to accidentally touch the terminals when power is being applied.

- (1) You can move between the parameters in each parameter setting display using the  key.
- (2) To change the parameter setpoint,
 - (i) Change the display value with the  or  key (the period flashes).
 - (ii) Press the  key to register the setpoint.
- (3) In the operating display ①, ② or ③, pressing the  key for at least 3 seconds retrieves the operating parameter setting display.
- (4) In the operating parameter setting display, pressing the  key for at least 3 seconds transfers back to the operating display ①.
 Registering the parameter PRG to “1” retrieves the program parameter setting display.
 Registering the key-lock parameter LOC to “-1” retrieves the setup parameter setting display.
- (5) In the setup parameter setting display, pressing the  key for at least 3 seconds transfers back to the operating display ①.
- (6) In the program parameter setting display, pressing the  key for at least 3 seconds transfers back to the operating display ①.

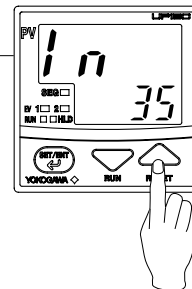

● UP150 Measured Input Ranges

Input type	Range (°C)	Range code (°C)	Range (°F)	Range code (°F)	
Unspecified		OFF			
Thermocouple	K	-270 to 1370°C	1	-300 to 2500°F	31
		0.0 to 600.0°C	2	32.0 to 999.9°F	32
		0.0 to 400.0°C	3	32.0 to 750.0°F	33
		-199.9 to 200.0°C	4	-300 to 400°F	34
	J	-199.9 to 999.9°C	5	-300 to 2100°F	35
	T	-199.9 to 400.0°C	6	-300 to 750°F	36
	E	-199.9 to 999.9°C	7	-300 to 1800°F	37
	R	0 to 1700°C	8	32 to 3100°F	38
	S	0 to 1700°C	9	32 to 3100°F	39
	B	0 to 1800°C	10	32 to 3200°F	40
	N	-200 to 1300°C	11	-300 to 2400°F	41
	L	-199.9 to 900.0°C	12	-300 to 1600°F	42
	U	-199.9 to 400.0°C	13	-300 to 750°F	43
	Platinel 2	0 to 1390°C	14	32 to 2500°F	44
RTD	Pt100	-199.9 to 850.0°C	15	-199.9 to 999.9°F	45
		0.0 to 400.0°C	16	32.0 to 750.0°F	46
		-199.9 to 200.0°C	17	-300 to 400°F	47
		-19.9 to 99.9°C	18	-199.9 to 999.9°F	48
	JPt100	-199.9 to 500.0°C	19		
DC voltage	0 to 100mV	0.0 to 100.0	User-scalable	20	
	0 to 5V	0.000 to 5.000		21	
	1 to 5V	1.000 to 5.000		22	
	0 to 10V	0.00 to 10.00		23	



For example, to select thermocouple type J (°F), set the range code to 35.



At power-on, the program temperature controller displays the operating display ①, but if the measured input type setting remains OFF, “IN” appears. In this case, press the  key to display the measured input range code you want to use, then press the  key to register it. (Refer to the flowchart on page 12 and 13.)



The controller is shipped with the parameters set at the factory-set defaults. Check the default values against the “Parameter Lists” in the page 14 and 15, and change the parameter setpoints that need to be changed.









This section explains how to set and register parameter values.

The procedure for changing Control Mode (CTL) can be found on “Changing Control Mode (CTL).”

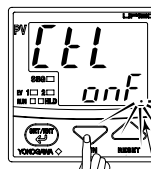
You can set the other parameters in the same way.

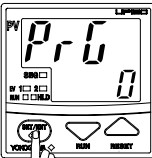
There are no parameter displays for parameters specific to functions, such as the optional external contact inputs functions, if they were not selected at ordering.

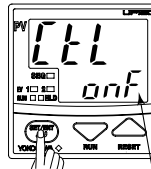
■ Changing Control Mode (CTL)

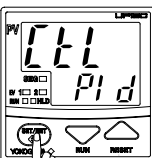
<p>Step 1: Press the  key for at least 1 second to reset the program operation, and confirm that the UP150 shows the operating display ①, ② or ③.</p>  <p>Confirm that “RUN” lamp is not lit.</p>	<p>Step 4: When On/off control mode is required, press the  key to change control mode to On/off.</p>  <p>The period flashes.</p>
<p>Step 2: To enter the operating parameter setting display, press the  key for at least 3 seconds.</p> <ul style="list-style-type: none">• “PRG” parameter appears in the PV display. 	<p>Step 5: Press the  key once to register the setting. Control mode is now changed.</p> <p>To return to the operating display ①, press the  key for at least 3 seconds.</p>  <p>The period goes out.</p>
<p>Step 3: Press the  key once to display “CTL” parameter. In this example, PID control mode is selected.</p> 	



Changing certain setup parameter may automatically initialize the operating parameters. Therefore, after you change the setup parameters, always check the operating parameter setpoints to find out if appropriate values have been set for them. If the operating parameters have been initialized, set them to their appropriate values.

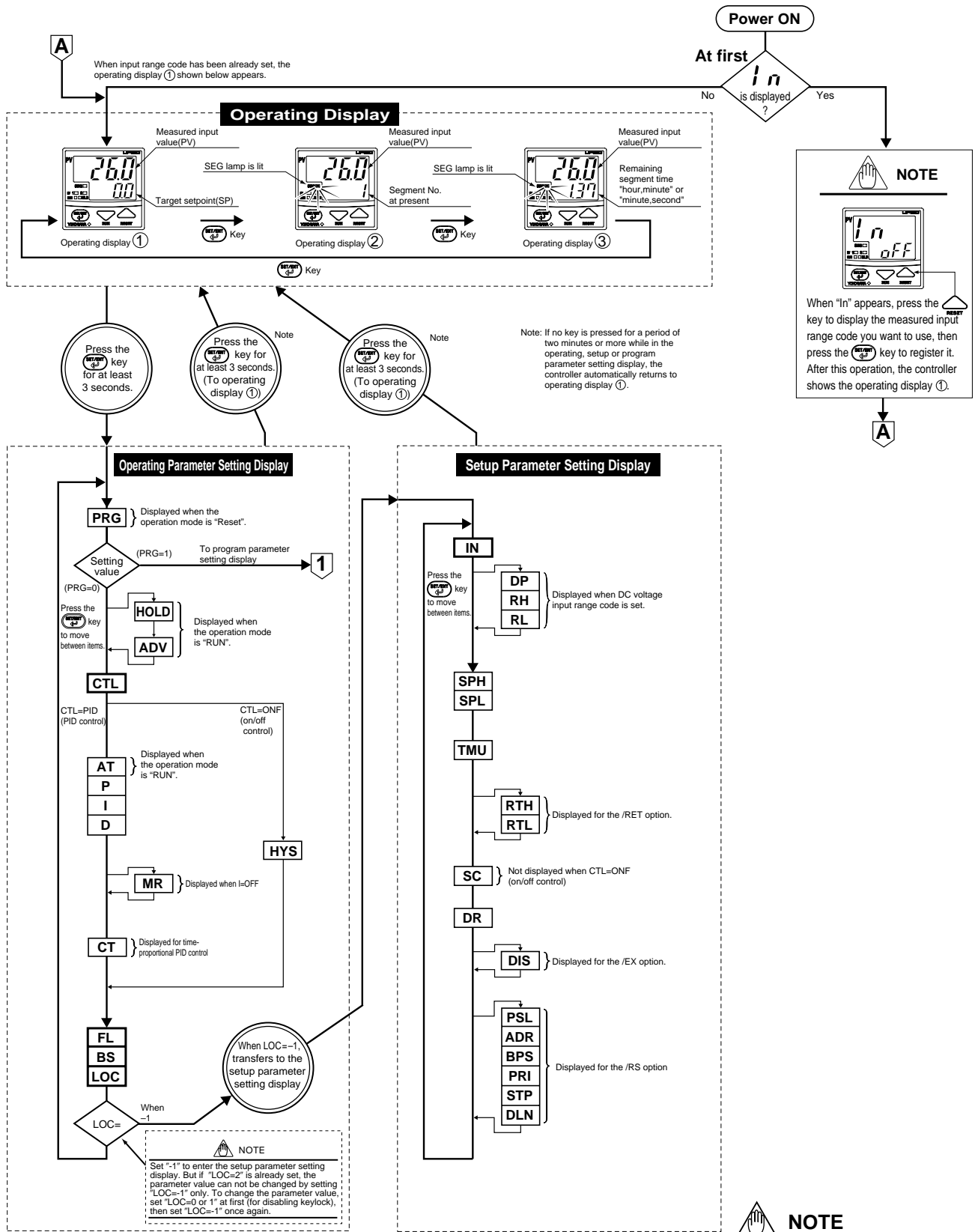

Changing certain setup parameters may automatically initialize the operating parameters. Therefore, after you change the setup parameters, always check the operating parameter settings to find out if appropriate values have been set for them. If the operation parameters have been initialized, set them to their appropriate values.

To Operating Display

Note: If no key is pressed for a period of two minutes or more while in the operating, setup or program parameter setting display, the controller automatically returns to operating display ①.

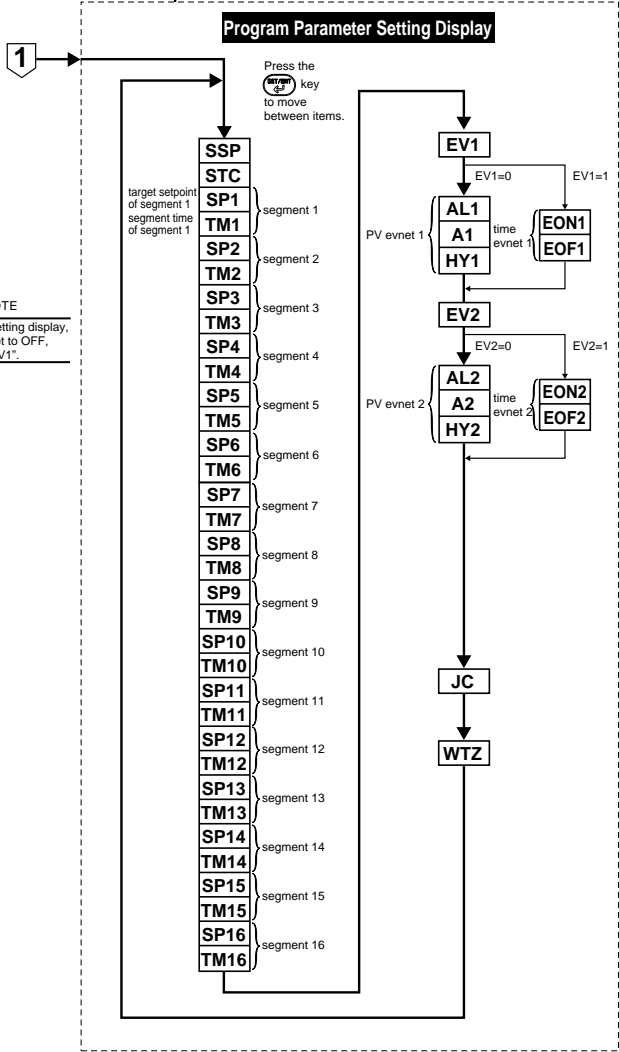
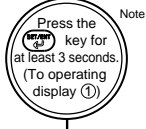

NOTE

In program parameter setting display, if "TMn" (n=1 to 16) is set to OFF, the controller goes to "EV1".

Parameter Lists

Parameters changed rather frequently during operation.

(1) Operating Parameters

When creating a program, set the parameter PRG=1 to display the program parameter setting display.

Numbers in () are the parameter setpoints that apply when the communication function is used. Ex. OFF(0), ON(1)

Code	Name	Setting range and unit	Default	User setting
PRG <i>PRG</i>	Program parameter setting	0: Go to "CTL" setting display. 1: Enter the program parameter setting display (Displayed when a program operation is stopped.)	0	
HOLD <i>Hold</i>	Program hold	OFF(0): Cancel Hold ON(1): Hold (Displayed when a program operation is started.)	OFF(0)	
ADV <i>Adv</i>	Segment advance	OFF(0): Not execute advance ON(1): Execute advance (Displayed when a program operation is started.)	OFF(0)	
CTL <i>CTL</i>	Control mode	ONF(0): On/off control PID(1): PID control	PID(1)	
AT <i>At</i>	Auto-tuning	OFF(0): Stop auto-tuning ON(1): Start auto-tuning (Displayed when a program operation is started.)	OFF(0)	
P <i>P</i>	Proportional band	1°C/°F to the temperature that corresponds to 100% of the measured input range (scale) span	5% of measured input range (scale) span	
I <i>I</i>	Integral time	1 to 3600 seconds; OFF(0): No integral action	240 seconds	
D <i>d</i>	Derivative time	1 to 3600 seconds; OFF(0): No derivative action	60 seconds	
MR <i>nr</i>	Manual reset	-100 to 100%	50.0%	
HYS <i>HYS</i>	Hysteresis for on/off control	0°C/°F to the temperature that corresponds to 100% of the measured input range (scale) span	0.5% of measured input range (scale) span	
CT <i>ct</i>	Control output cycle time	1 to 240 seconds	30 seconds	
FL <i>FL</i>	PV input filter	OFF(0), 1 to 120 seconds	OFF(0)	
BS <i>bs</i>	PV input bias	-100 to 100% of measured input range (scale) span	0% of measured input range (scale) span	
LOC <i>LoL</i>	Key lock	0: No key lock (Note) 1: No key lock (Note) 2: Prevents all parameter changing operations -1: Set "-1" to enter the setup parameter setting display. But if "LOC=1 or 2" is already set, the parameter value can not be changed by setting "LOC=-1" only. To change the parameter value, set "LOC=0" at first (for disabling keylock), then set "LOC=-1" once again. (Note) Both 0 and 1 are No key lock.	0	

(2) Setup Parameters Parameter rarely changed in normal use after once having been set.

Numbers in () are the parameter setpoints that apply when the communication function is used. Ex. OFF(0), ON(1)

Code	Name	Setting range and unit	Default	User setting
IN <i>ln</i>	Measured input type	1 to 23, 31 to 48 (See measured input range code list.) (See page3) OFF(0): No input (If no measured input type is specified at the time of ordering, you must set the measured input type.)	OFF(0) or the input range code specified with order	
DP <i>dp</i>	Decimal point position of measured input	0: No decimal place (nnnn) (Displayed at voltage input) 1: One decimal place (nn.n) 2: Two decimal places (nn.nn) 3: Three decimal places (n.nnn)	1	
RL <i>rH</i>	Maximum value of measured input scale	(RL + 1) to 9999 (Displayed at voltage input)	100.0	
RL <i>rL</i>	Minimum value of measured input scale	-1999 to (RH -1) (Displayed at voltage input)	0.0	
SPH <i>SPH</i>	Maximum value of program setting range	(SPL+1digit) to max. value of measured input range (scale). Min value of measured input range (scale) to (SPH-1digit) Unit:°C/°F Note that SPL<SPH	Maximum value of measured input range (scale)	
SPL <i>SPL</i>	Minimum value of program setting range	Place limits on the program setting range within the measured input range (scale) to prevent a program setpoint from being beyond the limits of setting range by mistake.	Minimum value of measured input range (scale)	
TMU <i>tnu</i>	Program time unit	Sets the time unit of a program. 0: hour,minute 1: minute,second	0	
RTH <i>rth</i>	Maximum value of retransmission output	Temperature input : Within measured input range Voltage input : (RTL+1digit) to max. value of measured input scale (RH) Min. value of measured input scale (RL) to (RTH-1digit) However, RTL<RTH	Maximum value of measured input range (scale)	
RTL <i>rtl</i>	Minimum value of retransmission output		Minimum value of measured input range (scale)	
SC <i>SL</i>	SUPER function	ON(1): Uses the SUPER function OFF(0): Does not use SUPER function	OFF(0)	
DR <i>dr</i>	Direct/reverse action	0: Reverse action 1: Direct action	0	
DIS <i>dis</i>	DI-function selection	OFF(0):Function of /EX does not work ON(1):Terminals (3)-(5) Hold when DI=ON Cancel hold when DI=OFF Terminals (4)-(5) Start program operation when DI=ON Stop program operation when DI=OFF Note: When DIS=ON, the operation mode can not be changed by key operation. However, only the RESET key is operable.	OFF(0)	
PSL <i>PSL</i>	Protocol selection	0: PC-link communication 1: PC-link communication with sum check 2: Ladder communication 3: MODBUS in ASCII mode 4: MODBUS in RTU mode	0	
ADR <i>Adr</i>	Controller address	1 to 99 However, the number of controllers that can be connected per host device is 31 at the maximum.	1	
BPS <i>bPS</i>	Baud rate	2.4(0): 2400 bps 4.8(1): 4800 bps 9.6(2): 9600 bps	9.6(2)	
PRI <i>Pri</i>	Parity	NON(0): Disabled EVN(1): Even parity ODD(2): Odd parity	EVN(1)	
STP <i>STP</i>	Stop bit	1 or 2 bits	1 bit	
DLN <i>dLn</i>	Data length	7 or 8 bits • 8 bits when ladder, MODBUS (RTU) • 7 bits when MODBUS (ASCII)	8 bits	

(3) Program Parameters Parameters for creating a program.

Numbers in () are the parameter setpoints that apply when the communication function is used. Ex. OFF(0), ON(1)

Code	Name	Setting range and unit	Default	User setting
SSP SSP	Starting target setpoint	0 to 100% of measured input range (scale) span Unit: °C/°F	Min. value of measured input range (scale)	
STC STC	Start code	0: Program operation begins with the starting target setpoint. 1: Ramp-prioritized PV start (program operation begins with the PV value by giving priority to the ramp of segment 1) 2: Time-prioritized PV start (program operation begins with the PV value by giving priority to the time of segment 1)	0	
SP1 SP1	Target setpoint 1	0 to 100% of measured input range (scale) span Unit: °C/°F	Min. value of measured input range (scale)	Use the table blow
TM1 TM1	Segment time 1	OFF(-1) or 0.00 to 99.59 (hour, min. or min, second) Time unit is to be set in "TMU" parameter.	OFF(-1)	Use the table blow
*Note	⋮	⋮	⋮	⋮
SP16 SP16	Target setpoint 16	0 to 100% of measured input range (scale) span Unit: °C/°F	Min. value of measured input range (scale)	Use the table blow
TM16 TM16	Segment time 16	OFF(-1) or 0.00 to 99.59 (hour, min. or min, second) Time unit is to be set in "TMU" parameter.	OFF(-1)	Use the table blow
EV1 EV1	Event 1 type	0: PV event 1: Time event	0	
AL1 AL1	PV event 1 type	OFF(0) or 1 to 10 (see the table of PV event function list in User's Manual for Programming/Operation)	1	
A1 A1	PV event 1 setpoint	• PV alarm: Min. value of measured input range (scale) to Max. value of measured input range (scale) • Deviation alarm: -100 to 100% of measured input range (scale) span Unit: °C/°F	Max. value of measured input range (scale) (PV alarm)	
HY1 HY1	PV event 1 hysteresis	0 to 100% of measured input range (scale) span Unit: °C/°F	0.5% of measured input range (scale) span	
EON1 EON1	Time event 1 on time	OFF(-1) or 0.00 to 99.59 (hour, min. or min, second) Time unit is the same as that of the program.	OFF(-1)	
EOF1 EOF1	Time event 1 off time	OFF(-1) (Note) or 0.00 to 99.59 (hour, min. or min, second) Note: Time event 1 does not stop when "OFF" is set.	OFF(-1)	
EV2 EV2	Event 2 type	0: PV event 1: Time event	0	
AL2 AL2	PV event 2 type	OFF(0) or 1 to 10 (see the table of PV event function list in User's Manual for Programming/Operation)	2	
A2 A2	PV event 2 setpoint	• PV alarm: Min. value of measured input range (scale) to Max. value of measured input range (scale) • Deviation alarm: -100 to 100% of measured input range (scale) span Unit: °C/°F	Max. value of measured input range (scale) (PV alarm)	
HY2 HY2	PV event 2 hysteresis	0 to 100% of measured input range (scale) span Unit: °C/°F	0.5% of measured input range (scale) span	
EON2 EON2	Time event 2 on time	OFF(-1) or 0.00 to 99.59 (hour, min. or min, second) Time unit is the same as that of the program.	OFF(-1)	
EOF2 EOF2	Time event 2 off time	OFF(-1) (Note) or 0.00 to 99.59 (hour, min. or min, second) Note: Time event 2 does not stop when "OFF" is set.	OFF(-1)	
JC JC	Junction code	0: Reset 1: Hold 2: Repeat (repeat endlessly)	0	
WTZ WTZ	Wait zone	OFF(0) or 0 to 10% of measured input range (scale) span	OFF(0)	

*Note: • The setting range (scale) and unit of SPn (n=2 to 15) are same as those of SP1 (and SP16)
• The setting range (scale) and unit of TMn (n=2 to 15) are same as those of TM1 (and TM16)

■ User Setting Table of Target SP and Segment time

	n=1	n=2	n=3	n=4	n=5	n=6	n=7	n=8	n=9	n=10	n=11	n=12	n=13	n=14	n=15	n=16
SP n (n=1 to 16)																
TM n (n=1 to 16)																

■ Description of Parameters

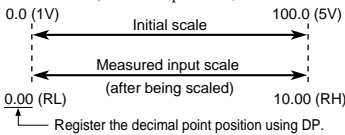
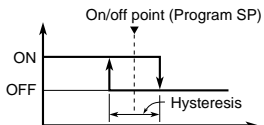
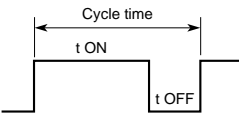
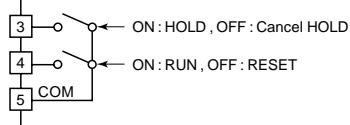
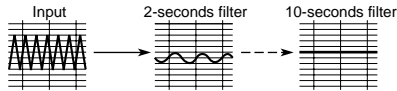
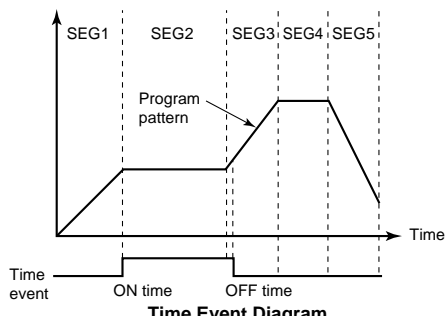
Parameter	Function	Parameter	Function
Control mode CTL	UP150 has two control mode. Select one from the following: a. PID control (PID) b. On/off control (ONF)	Decimal point of measured input DP	For DC voltage input, the input signal can be scaled for the particular engineering unit. For example, if you set the input type (IN) at range code 22, the initial range is 0.0 to 100.0. a. Using DP, set the decimal point position fit for the engineering unit you want to use. (In the example below, the 2 digits to the right of the decimal point) b. Next, register the scale values of the measured input scale using RH and RL. (In the example below, RH=10.00 and RL=0.00)
Manual reset MR	You can set this parameter only for control without an integral action (when registered as CTL=PID and I=OFF). The controller outputs the manual reset (MR) value when PV=SP. For example, if you set MR=50%, the controller outputs (OUT) 50% when PV=SP.	Maximum/minimum value of measured input scale RH, RL	
Hysteresis for on/off control HYS	For on/off control (CTL=ONF), you can set a hysteresis around the on/off point (SP) to prevent chattering. 	SUPER function selection SC	The SUPER function is effective in the following cases: a. An overshoot must be suppressed. b. The rise-up time needs to be shortened. c. The load often varies. Note 1: The SUPER function will not work when on/off control is selected, or I or D constants is set at OFF in PID control. Note 2: For some types of systems, the SUPER function may not be so useful. If this is the case, turn off the function.
Control output cycle time CT	The cycle time is the period of on/off repetitions of a relay or voltage pulse output in time proportional PID control. The ratio of the ON time to the cycle time is proportional to the control output value. 	DI-function selection DIS	<ul style="list-style-type: none"> When DIS=ON, Mode can be switched by only external contact input signal.  <ul style="list-style-type: none"> In order to switch the Mode by key operation, OFF must be set at DIS. Note: UP150 can be switched into "RESET" mode by key operation even if DIS=ON.
PV input filter FL	This function should be used when the PV display value may fluctuate greatly, for example, when the measured input signal contains noise. The filter is of the first-order lag type, and FL sets the time constant. If a larger time constant is set, the filter can remove more noise. 	Hysteresis for PV events 1 and 2 HY1, HY2	The PV events are output as relay outputs. Since a relay has a limited service life, excessive on/off actions will shorten the life of a relay. To prevent this, you can set a hysteresis band for both PV events 1 and 2 to moderate excessive on/off actions.
PV input bias BS	This function adds a bias value to the measured input value, and the result is used for display and control computation. $\text{PV value inside the controller} = \text{measured input value} + \text{PV input bias}$ This function is useful for carrying out fine adjustment when the PV value is within the required accuracy but it differs from the value obtained by other equipment.	Time event n* on time n*=1 or 2 EON1 EON2	The time event feature begins countdown when a program starts running, and after the elapse of a preset time, output an on-time event signal (contact output ON) or off-time event signal (contact output OFF). 
		Time event n* off time n*=1 or 2 EOF1 EOF2	

8. PROGRAMMING

To operate the controller using a program, first create the program. The UP150 have one program pattern.

Program operation is based on a program pattern consisting of up to 16 segments as shown in the figure below. To create a program pattern, set the target setpoint to be reached and segment time for each segment. Two PV events and/or two time events can be set for a program.

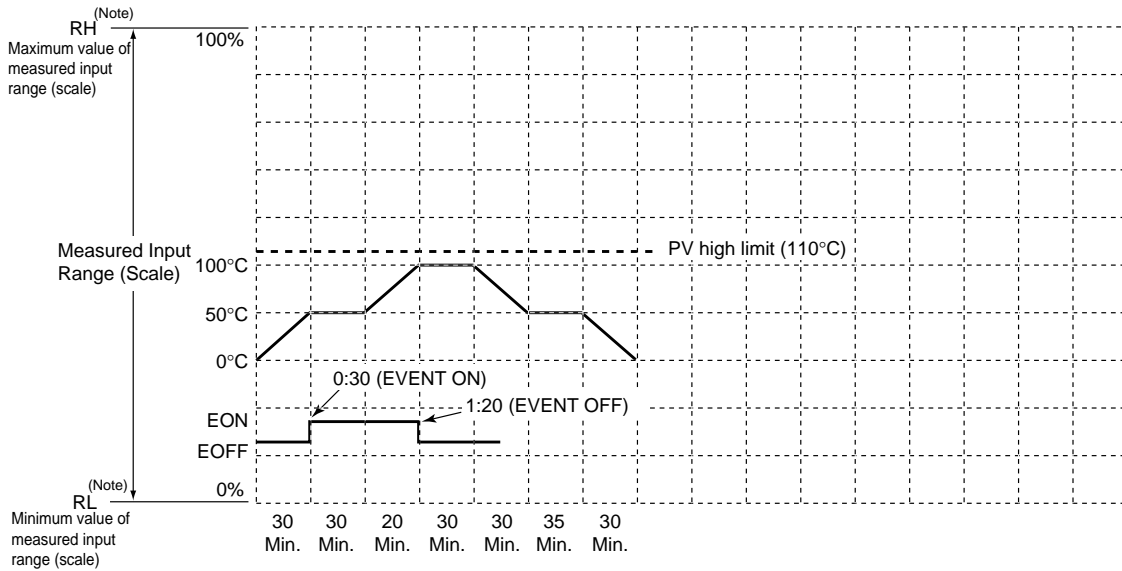

(Note) Displayed only for DC voltage input.

Starting target setpoint value (SSP)	0 °C
Start code (STC)	0 (program operation begins with the starting target setpoint)
Junction code (JC)	0 (reset)

Segment No.	1	2	3	4	5	6	7	8	9	10	11	12	13	14	15	16
Target setpoint (SP)	50°C	50°C	100°C	100°C	50°C	50°C	0°C									
Segment time (TM) (hour.minute or minute.second) Use the TMU setup parameter to set the time unit.	0:30	0:30	0:20	0:30	0:30	0:35	0:30									
Time event 1 (EV1=1)	EON1	0:30														
	EOF1	1:20														
PV event 1 (EV1=0)	AL1) Can not be used in this example because Event 1 is used as time event.														
	A1															
	HY1															
Time event 2 (EV2=1)	EON2) Can not be used in this example because Event 2 is used as PV event.														
	EOF2															
PV event 2 (EV2=0)	AL2	1(PV high limit)														
	A2	110°C														
	HY2	10°C														

Example of Program Pattern Settings

■ Program Pattern Setting Table

Device name	
Program name	
Model name	
Serial No.	

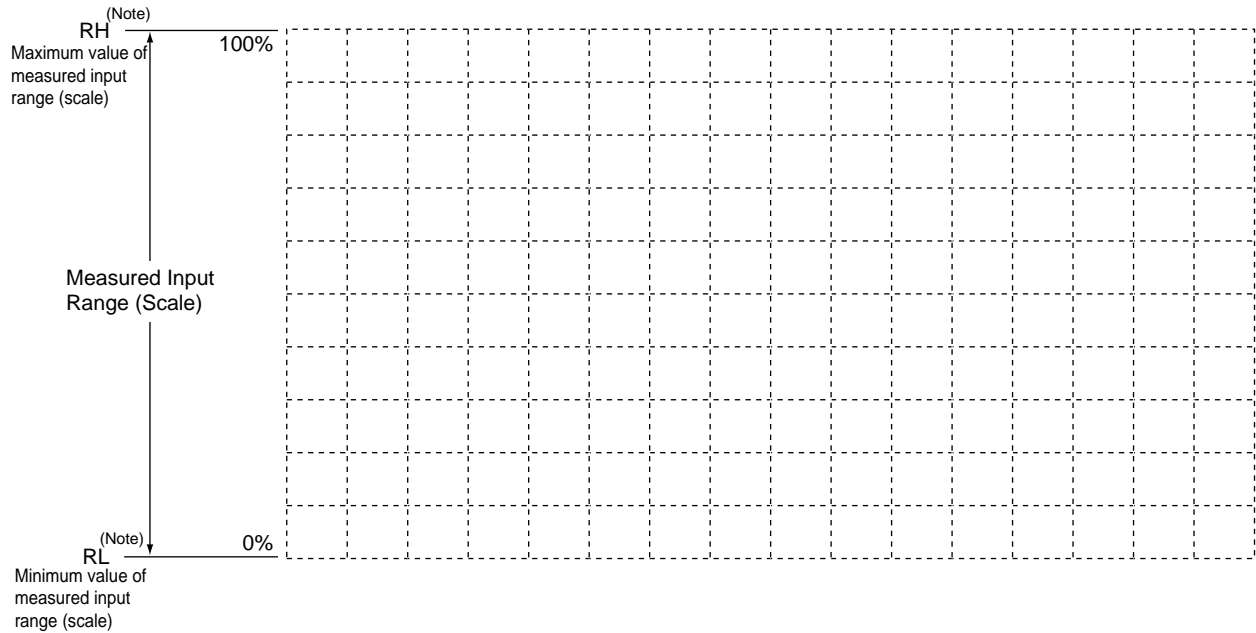

(Note) Displayed only for DC voltage input.











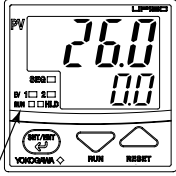

Starting target setpoint value (SSP)	
Start code (STC)	
Junction code (JC)	

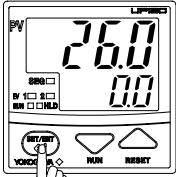
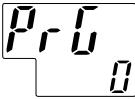
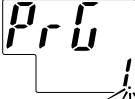
Segment No.		1	2	3	4	5	6	7	8	9	10	11	12	13	14	15	16
Target setpoint (SP)																	
Segment time (TM) (hour.minute or minute.second) Use the TMU setup parameter to set the time unit.																	
Time event 1 (EV1=1)	EON1																
	EOF1																
PV event 1 (EV1=0)	AL1																
	A1																
	HY1																
Time event 2 (EV2=1)	EON2																
	EOF2																
PV event 2 (EV2=0)	AL2																
	A2																
	HY2																

■ Creating the Program

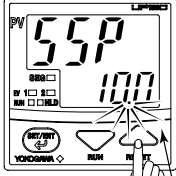

Before creating the program, reverify the Measured Input Type (IN), Maximum Value of Measured Input Scale (RH), Minimum Value of Measured Input Scale (RL), and Control Mode (CTL) parameters.

<p>Step 1: Press the  key for at least 1 second to reset the program operation, and confirm that the UP150 shows the operating display ①, ② or ③.</p>	 <p>Confirm that "RUN" lamp is not lit.</p>
<p>Step 2: To enter the program parameter setting display, do key operation as follows.</p> <p>[1] Press the  key for at least 3 seconds to display "PRG".</p> <p>[2] Press the  key once to display "1". The period flashes while the value is being changed.</p> <p>[3] Press the  key once to display "SSP" in the program parameter setting display.</p>	   
<p>Step 3: Set the parameters from "SSP" to "WTZ" by using the ,  and  keys.</p> <ul style="list-style-type: none"> • Use the  or  key to change the value of parameters. • Use  key to register the setpoint. • When "creating program" is finished, press the  key for at least 3 seconds to return to the operating display ①. 	 <p>The period flashes during change.</p> <p>The period is lit or goes out after registration.</p>

■ Deleting the Program Segment

To delete a part of the program pattern, set the segment time of the segment to be deleted ("TMn" n=1 to 16) to OFF, referring to "■ Creating the program."

Note : If the segment time of the halfway segment is set to OFF, all of the following segment will not be displayed. Be careful!

■ Start Program Operation

“Creating the program” must be finished before starting program operation.

Step 1:
Confirm that the controller shows the operating display ①, ② or ③.

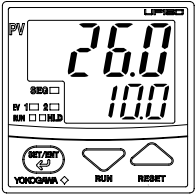

Step 2:
Press the  key for at least 1 second.
“RUN” lamp is lit, and starts the program operation.

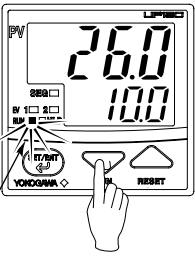

“RUN” lamp is lit.

■ Reset (Stop) Program Operation

Step 1:
Confirm that the controller is in program operation.

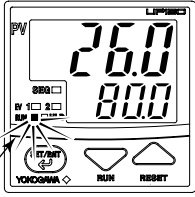

“RUN” lamp is lit.

Step 2:
Press the  key for at least 1 second.
“RUN” lamp goes out, and resets(stops) the program operation.

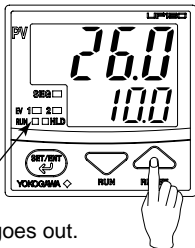

“RUN” lamp goes out.

Note:

- ① “Program operation” mode can be changed (run/reset) by key operation, communication or external contact input signal.
- ② When the program operation is reset (stopped), control action is also stopped, and the control output is to be 0% or OFF.

■ Programming

Before you begin programming, determine whether your programs are created using the time unit of “hour and minute” or “minute and second.” The controller is factory-set to the “hour and minute” time unit. To create programs using the “minute and second” time unit, change the setpoint of the TMU (Time Unit of Program) setup parameter to “1”.

Creating programs by setting target setpoint and segment time

As shown in the figure below, this method creates programs by setting a segment time and a target setpoint on a segment-by-segment basis.

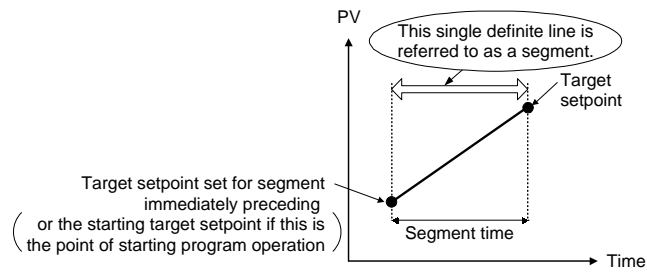

■ Conditions for Starting Program

1. Letting the controller run from a starting target setpoint

A starting target setpoint refers to a setpoint from which program operation begins. The controller operates in such a manner that the setpoint changes to the target setpoint over the segment time set for segment 1, irrespective of what the PV value is.

Controller Settings

Set the STC (Start Code) program parameter to "0".

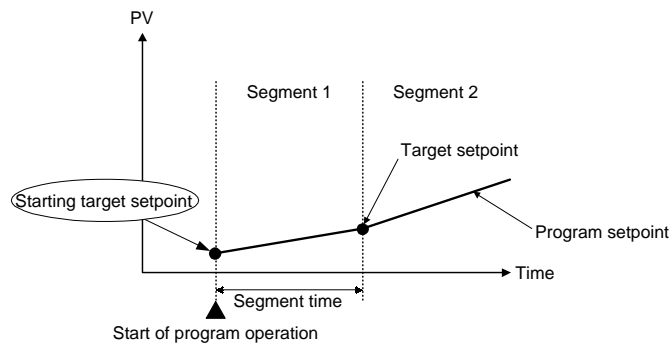

2. Letting the controller start from the current PV and run according to time settings defined for segment 1

Controller Settings

Set the STC (Start Code) program parameter to "2".

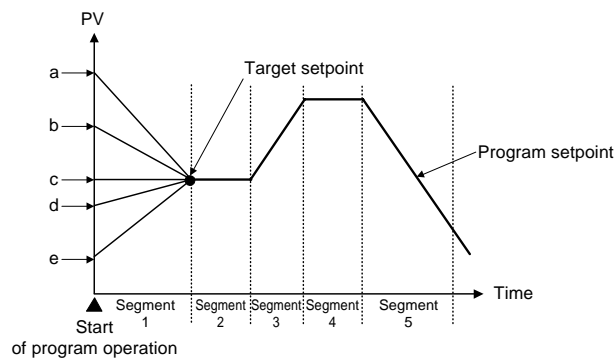

Starting Point of Operation	Controller Behavior
a	Begins to run from point a according to the time setting defined for segment 1.
b	Begins to run from point b according to the time setting defined for segment 1.
c	Begins to run from point c according to the time setting defined for segment 1.
d	Begins to run from point d according to the time setting defined for segment 1.
e	Begins to run from point e according to the time setting defined for segment 1.

3. Letting the controller start from the current PV and run according to ramp settings defined for segment 1

Controller Settings

Set the STC (Start Code) program parameter to "1".

(1) If segment 2 is a soak segment

Program operation starts from any of the points A (SSP) to C. For other information, see the following table.

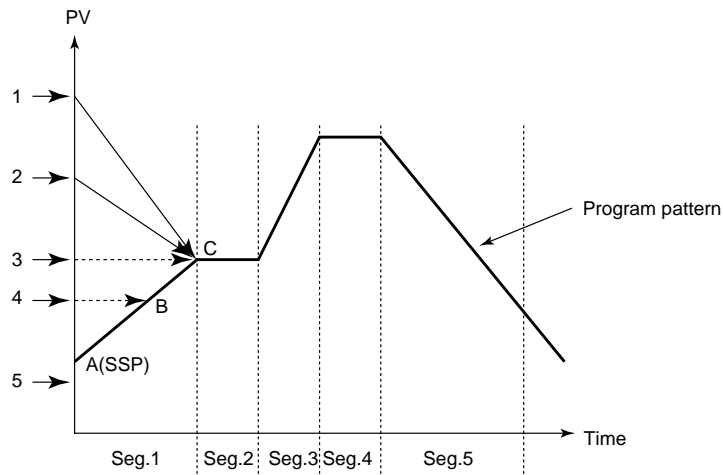

Example Where Segment 2 is a Soak Segment

The starting point of program operation is determined by where the measured input value (PV) is located at the time the operation starts.

Measured input value (PV) at startup of program operation	Starting point of program operation
1	C
2	C
3	C
4	B
5	A (SSP)

(2) If segment 3 is a soak segment:

The starting point of program operation is any of points A (SSP) to E.

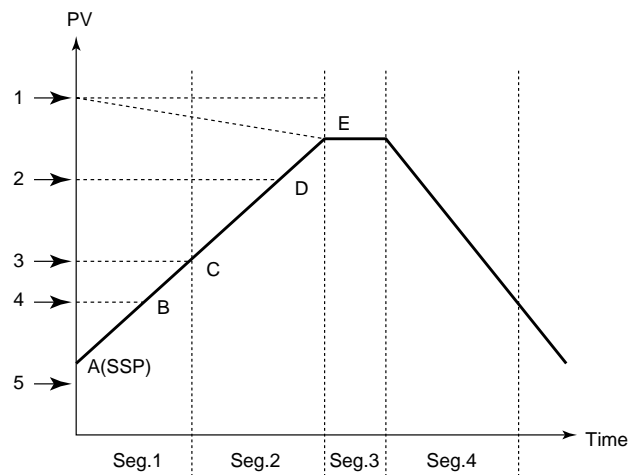

Example Where Segment 3 is a Soak Segment

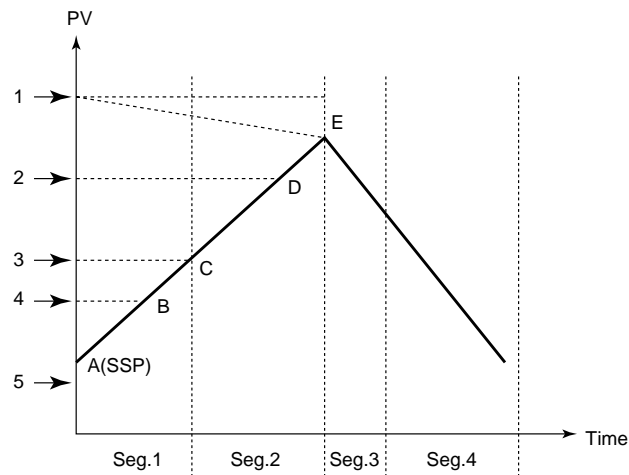

Example With No Soak Segment

The starting point of program operation is determined by where the measured input value (PV) is located at the time the operation starts.

Measured input value (PV) at startup of program operation	Starting point of program operation
1	E
2	D
3	C
4	B
5	A (SSP)

- (3) If the segment consists of an ascending gradient (ramp) only:
The starting point of program operation is any of points A (SSP) to D.

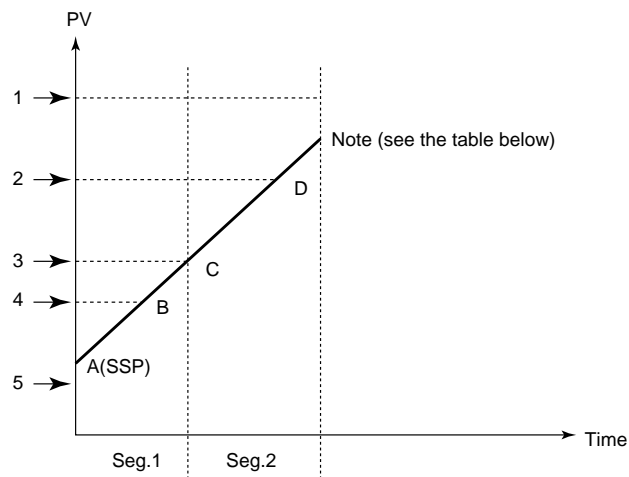

Example Where the Segment Consists of an Ascending Gradient (Ramp) Only

The starting point of program operation is determined by where the measured input value (PV) is located at the time the operation starts.

Measured input value (PV) at startup of program operation	Starting point of program operation
1	Program operation does not start up.
2	D
3	C
4	B
5	A (SSP)

- (4) In the case of other program pattern is set.
 The starting point of program operation is any of points A (SSP) to D.

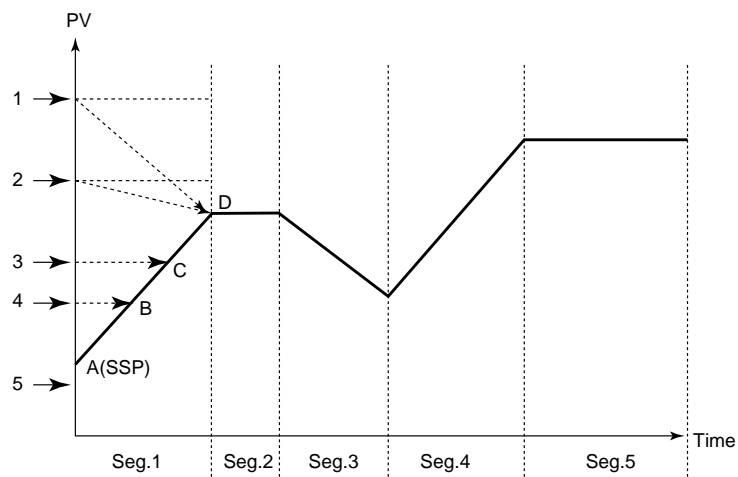
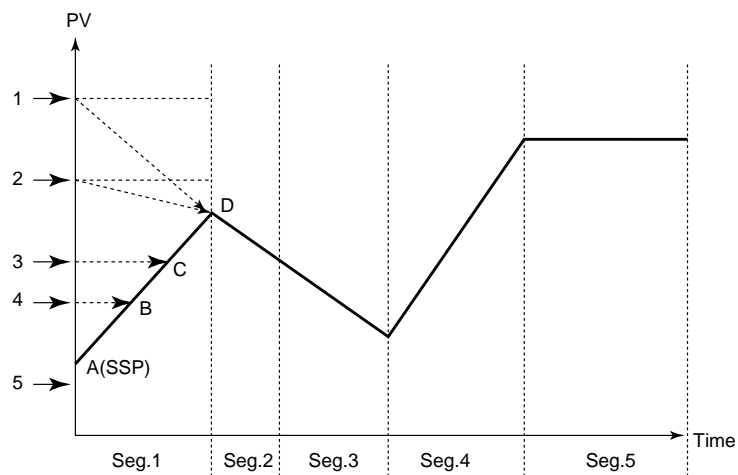

The starting point of program operation is determined by where the measured input value (PV) is located at the time the operation starts.

Measured input value (PV) at startup of program operation	Starting point of program operation
1	D
2	D
3	C
4	B
5	A (SSP)

■ PV Event Function List

PV event is the function to output the PV or deviation alarm related to the created program.

PV event (alarm) type	Action ("Opn" and "Cls" indicate that the relay contact is opened and closed; "(on)" and "(off)" indicate that the lamp is on and off; and white triangles indicate temperature control setpoints.	PV event type code		PV event (alarm) type	Action ("Opn" and "Cls" indicate that the relay contact is opened and closed; "(on)" and "(off)" indicate that the lamp is on and off; and white triangles indicate temperature control setpoints.	PV event type code	
		Closed contact during PV event (alarm)	Open contact during PV event (alarm)			Closed contact during PV event (alarm)	Open contact during PV event (alarm)
No alarm		OFF					
PV high limit		1		De-energized on deviation low limit			6
PV low limit		2		Deviation high and low limits		7	
Deviation high limit		3		Deviation within high and low limits		8	
Deviation low limit		4		De-energized on PV high limit		9	
De-energized on deviation high limit		5		De-energized on PV low limit		10	

■ Time Event

The time event feature begins countdown when a program starts running, and after the elapse of a preset time, output an on-time event (contact output ON) or off-time event (contact output OFF).

The time of time event is not elapsed during “Hold” or “Wait” status. When the “Advance” is executed, remaining time in the segment is canceled.

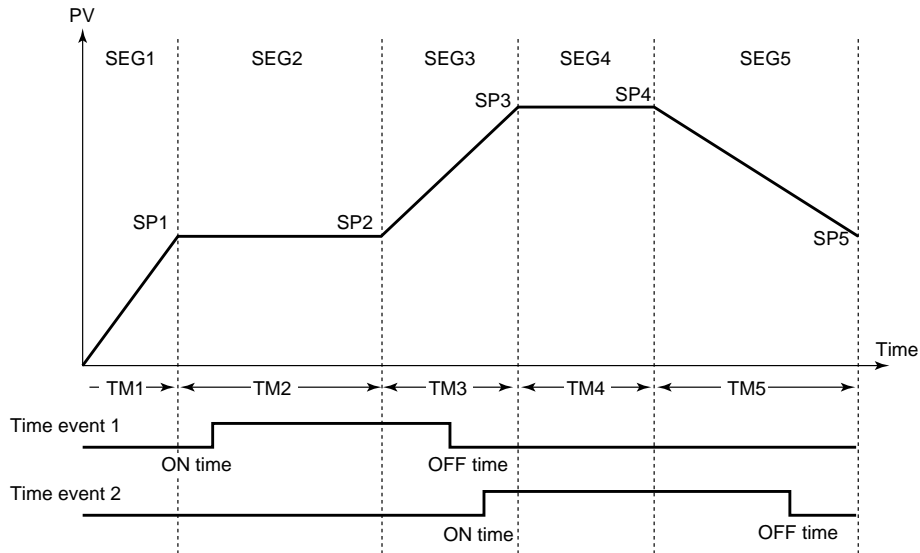

NOTE

- (1) When you don't want “event-OFF” at the end of program operation, set “OFF” to time event 1 or 2 off time (EOF1 or EOF2) of segment.
 - (2) When you want “event-ON” at the start of program operation, set “0.00” to time event 1 or 2 on time (EON1 or EON2) of final segment 1.
 - (3) When the time of events on/off time exceeds the setting time of program, these events do not work.
 - (4) Digital (Contact) output is OFF, when controller is in RESET mode.
 - (5) The previous event status are kept when controller is in Hold mode.
-

■ Wait Operation

During a segment transition, wait operation brings the transition to be next segment into a wait (standby) state, using the wait zone, until the deviation is canceled. The wait zone is a span of deviation that determines to what degree a PV input is tracked.

Wait operation is available only at a segment junction that transfers from ramp to soak.

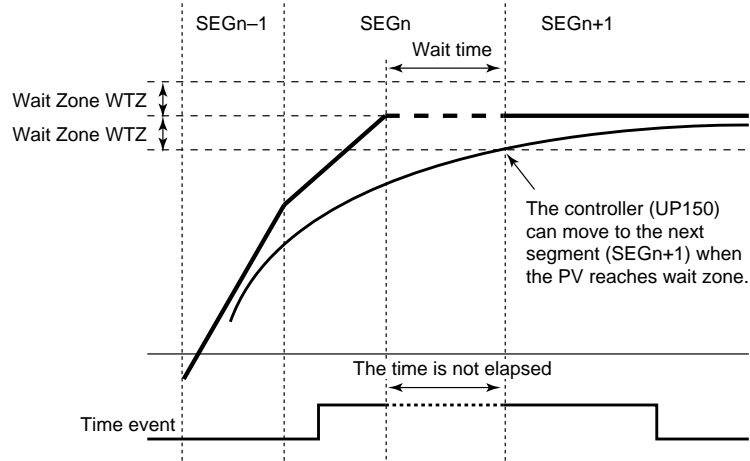

During the “wait”, the timer for the program pattern progress stops, so that time event (EVn) is held. (RUN lamp flashes.)

The PV event does not stop even if the controller is in the “wait”.

■ HOLD Function

During program operation, the time of “segment time” can be stopped by “HOLD function”.

When the controller is in “Hold”, the time of time events are also stopped. (PV events do not stop at this time.)

When program operation is held, time event and segment time are extended only by amount of the hold.

(1) “Hold” in soak segment

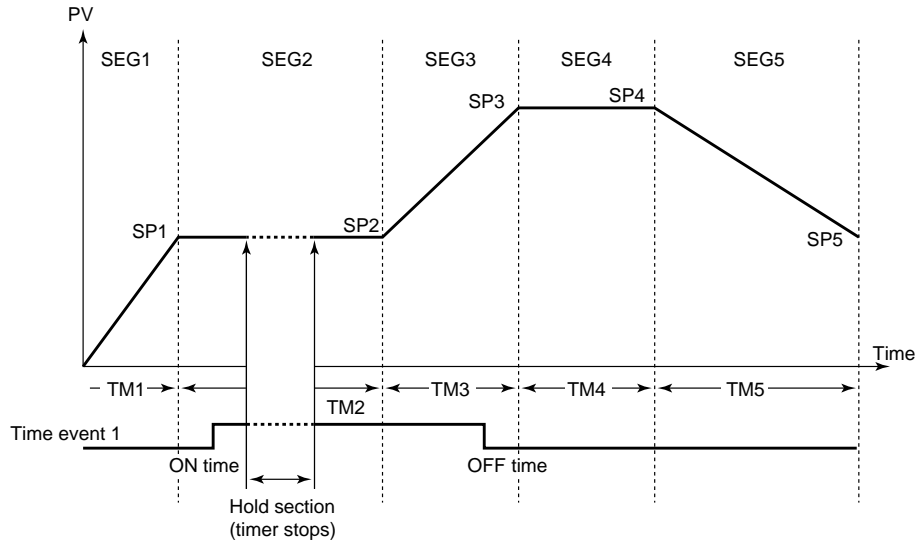

(2) “Hold” in ramp segment

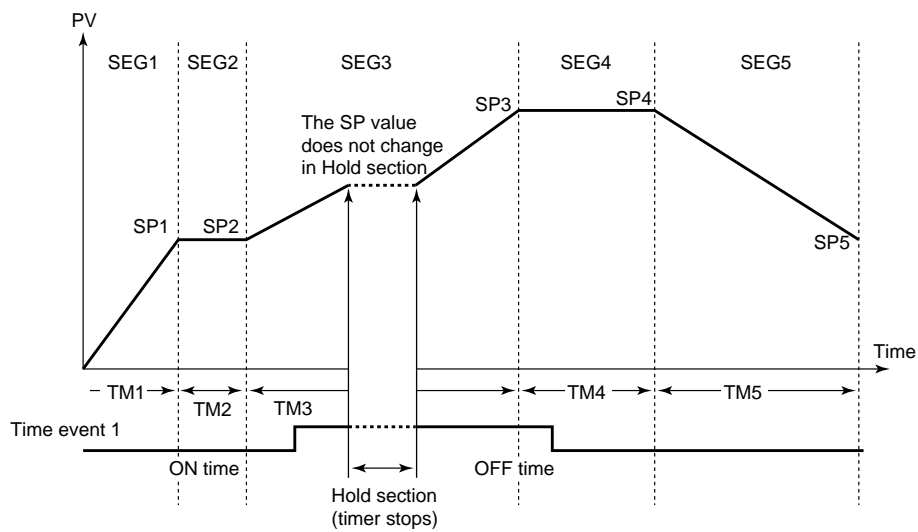

■ Advance Function

Advance (moving program pattern forward 1 segment) can be executed by key operation or via communication. If advance is executed at the final segment, the system operates according to the set junction code. If advance is executed during hold, hold is released. When advance is executed, time and event move forward.

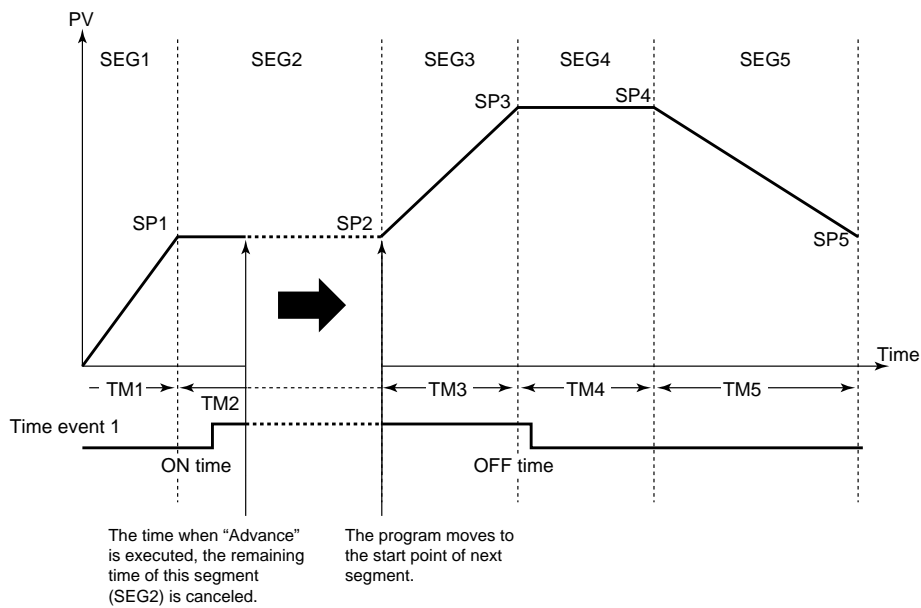

Effect on time events

When the ON/OFF action of time events is set in "time canceled section", the status of time events are changed, and these are kept in the next segment.

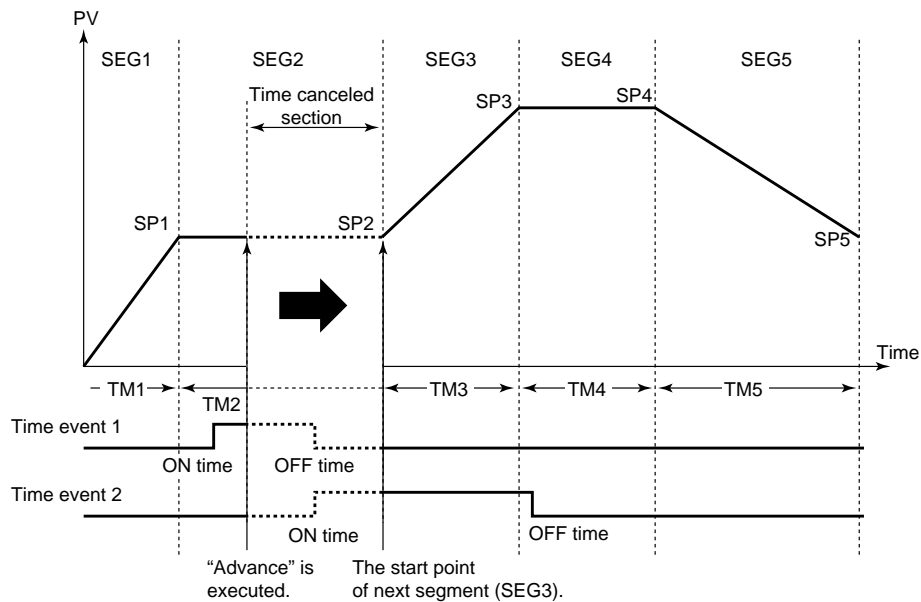

■ Junction Code

The operation at the end of program pattern can be specified by junction code (JC).

(1) Reset termination (JC = 0)

At program termination, the controller enters reset status. At this time, control output becomes 0% or OFF, and event status is OFF.

(2) Hold termination (JC = 1)

At program termination, the system enters hold status. At this time, control output and time event status are held (PV events do not stop at this time). The hold status continues until canceled by key operation or external contact input (digital input). When hold status is canceled, control output becomes 0% or OFF, and event status is OFF.

(3) Repeat (JC = 2)

At the program termination, the controller repeats execution of same program pattern. At the start of program operation, PV starts up with gradient-priority. At the start of second time or later where the repeat action is activated, the program operation always starts from "SSP" regardless of PV.

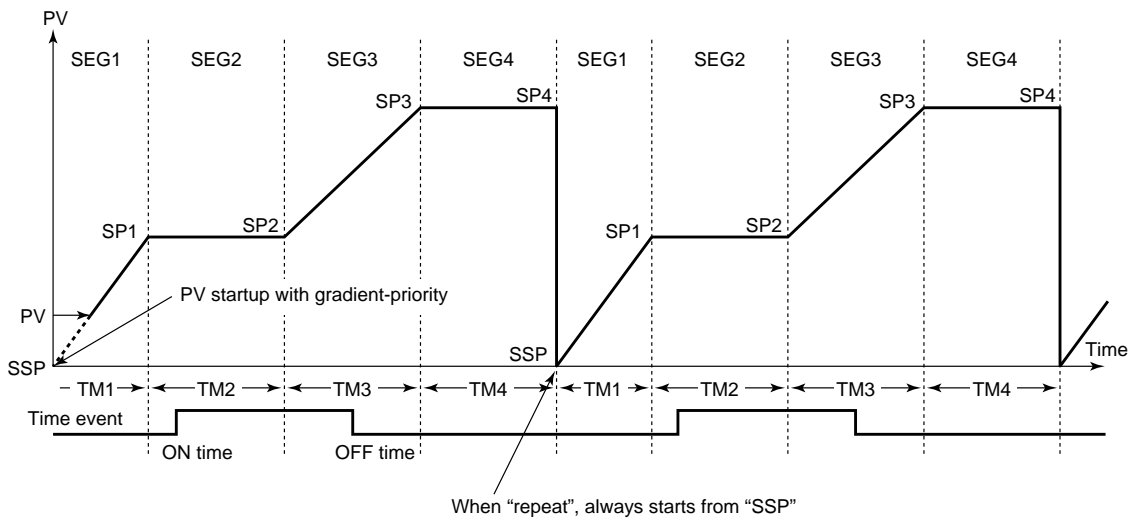

9. TROUBLESHOOTING

In the event of an abnormality, perform the following checks as outlined by the flowchart.

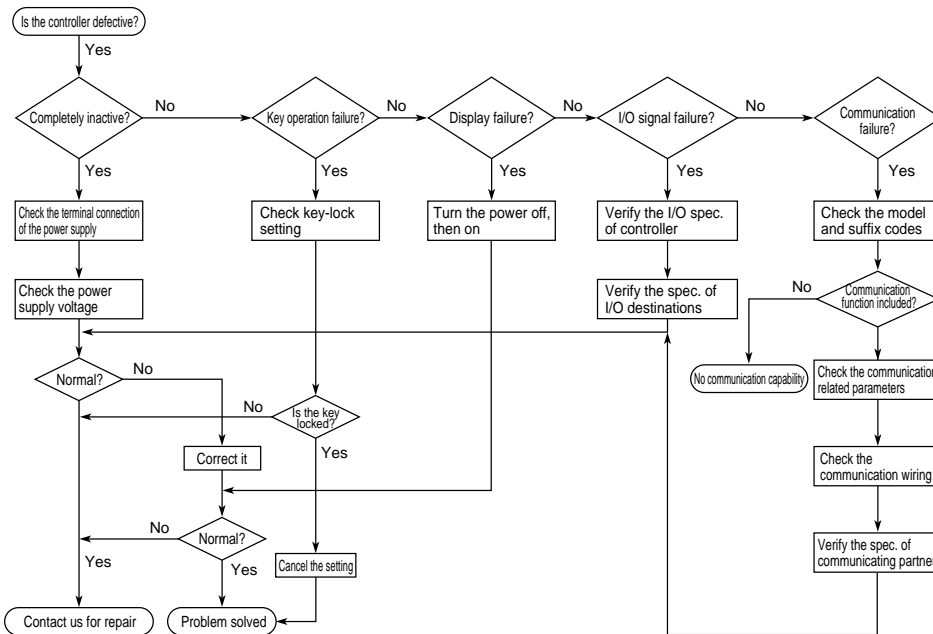

■ Error Display During Operation

(1) If the controller displays one of the following, carry out the appropriate remedy for the particular error.

Display	Error content	Remedy
<i>PEr</i> P.Er	The parameter is abnormal	Check the settings of all the parameters and set them at their proper values.
<i>b o</i> B.o	Input burnout	Check the sensor wiring and correct it.
<i>000</i> OOO	PV over-scale (PV exceeds its effective range.)	Check the input type and scale settings and correct them.
<i>UUU</i> UUU	PV under-scale (PV falls below its effective range.)	
Flashing period	Communication failure (for /RS option only)	Press any key to stop the flashing.

(2) The controller needs to be repaired if any of the indications in the table below appear.

In these cases, do not try to repair the controller yourself. Order a new controller or contact us for repair.

Display	Error content
Unknown (at power-on)	CPU failure
All extinguished (at power-on)	Power source failure
"Err" (at power-on)	Calibration abnormal
Flashing "Err" (at power-on)	RAM or ROM failure
Flashing "Err" (during operation)	A/D converter failure, RJC failure, or EEPROM failure

■ When Power Failure Occurred During Operation

- Momentary power failures shorter than 20ms (or shorter than 1ms for "/V24") have no effect on the controller operation (i.e., normal operation continues).
- For power failures of 20ms or longer (or of 1ms or longer for "/V24"), however the status will be as follows.
(The controller action at power recovery is the same as at power-on.)
 - Alarm (PV event) action: Continues
 - Setting parameters: Maintained
 - Auto-tuning: Canceled

YOKOGAWA

Yokogawa Electric Corporation

YOKOGAWA ELECTRIC CORPORATION

Network Solutions Business Division

2-9-32, Nakacho, Musashino-shi, Tokyo, 180-8750 JAPAN

Phone: +81-422-52-7179 Facsimile: +81-422-52-6793

Sales Branch Offices

Tokyo, Nagoya, Osaka, Hiroshima, Fukuoka

YOKOGAWA CORPORATION OF AMERICA

Headquarters

2 Dart Road, Newnan, GA. 30265-1094 U.S.A.

Phone: +1-770-253-7000 Facsimile: +1-770-251-0928

Sales Branch Offices / Texas, Chicago, Detroit, San Jose

YOKOGAWA EUROPE B. V.

Headquarters

Databankweg 20, 3821 AL Amersfoort THE NETHERLANDS

Phone: +31-334-64-1611 Facsimile: +31-334-64-1610

Sales Branch Offices / Houten (The Netherlands), Wien (Austria), Zaventem (Belgium), Ratingen (Germany), Madrid (Spain), Bratislava (Slovakia), Runcorn (United Kingdom), Milano (Italy), Vélizy villacoublay(France), Johannesburg(Republic of South Africa)

YOKOGAWA AMERICA DO SUL S.A.

Headquarters & Plant

Praca Acapulco, 31-Santo Amaro, Sao Paulo/SP, BRAZIL CEP-04675-190

Phone: +55-11-5681-2400 Facsimile: +55-11-5681-4434

YOKOGAWA ENGINEERING ASIA PTE. LTD.

Head office

5 Bedok South Road, Singapore 469270 SINGAPORE

Phone: +65-6241-9933 Facsimile: +65-6241-2606

YOKOGAWA ELECTRIC KOREA CO., LTD.

Seoul Sales office

395-70, Shindaebang-dong, Dongjak-gu, Seoul,156-010, KOREA

Phone: +82-2-3284-3000 Facsimile: +82-2-3284-3019

YOKOGAWA TAIWAN CORPORATION

Head office

17F, No.39, Sec. 1, Chung Hwa Road Taipei, 100 TAIWAN

Phone: +886-2-2314-9166 Facsimile: +886-2-2314-9918

YOKOGAWA AUSTRALIA PTY. LTD.

Head office

CentreCourt D1, 25-27 Paul Street North, North Ryde, N. S. W. 2113, AUSTRALIA

Phone: +61-2-9805-0699 Facsimile: +61-2-9888-1844

YOKOGAWA INDIA LTD.

Head office

40/4 Lavelle Road, Bangalore, 560 001, INDIA

Phone: +91-80-227-1513 Facsimile: +91-80-227-4270

LTD. YOKOGAWA ELECTRIC

Grokholskiy per. 13, Build. 2, 4th Floor, 129010, Moscow, RUSSIA FEDERATION

Phone: +7-095-737-7868 Facsimile: +7-095-737-7869
